

**Quality Products**  
**Swiftly Crafted**

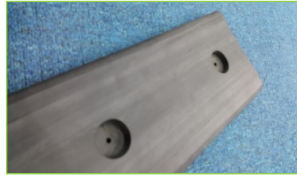

Science Park 3C



MTR  
Shatin Central Link  
In Progress

Link REIT  
Shopping centres

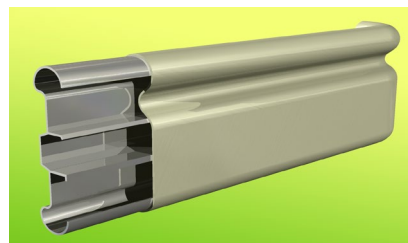
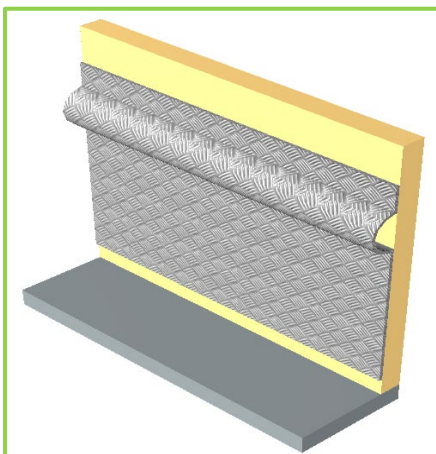

**Impact Resistance Wall**  
**Protection System**

# Impact Resistance Wall Protection System

## Content

- 1.0/ **System description**
  - 1.1/ Form and Function
  
- 2.0/ **ABC Wall Protection Range**
  - 2.1/ Bumper Guard
    - Flat Type
    - Curve Type
    - Heavy Duty Rubber
  
  - 2.2/ Corner Guard
    - Vinyl
    - Rubber for Child Centre
    - Heavy Duty Rubber
    - Metal
  
  - 2.3/ Handrail
    - Vinyl Flat Type
    - Vinyl Parasol Type
    - Vinyl Shell Type
    - Metal Type
  
  - 2.4/ Wall Cover
    - Vinyl
    - Metal Flat Type
    - Metal Bumpered Flat Type
  
- 3.0/ **Job Reference in Hong Kong**

## Form and Function

The challenge of building design is one of endurance in the face of the elements, for buildings with large traffic like entertainment arena and hospital, wall protection is one of the key items in providing the interior a nice outfit yet restinace to heavy impact.

Our extensive experience in vast and various hospitality building projects has allowed the team to develop the wall protection systems that comes with creative finish patterns and textures while at the same time offering impact protection to the wall from crowds and trolleys.

Our customization service offers you a tailor made design with both metal and vinyl materials.





# Australia Building Components

## Wall Protection System

### Bumper Guard

- Flat Type
- Model : WP-BG-F Series

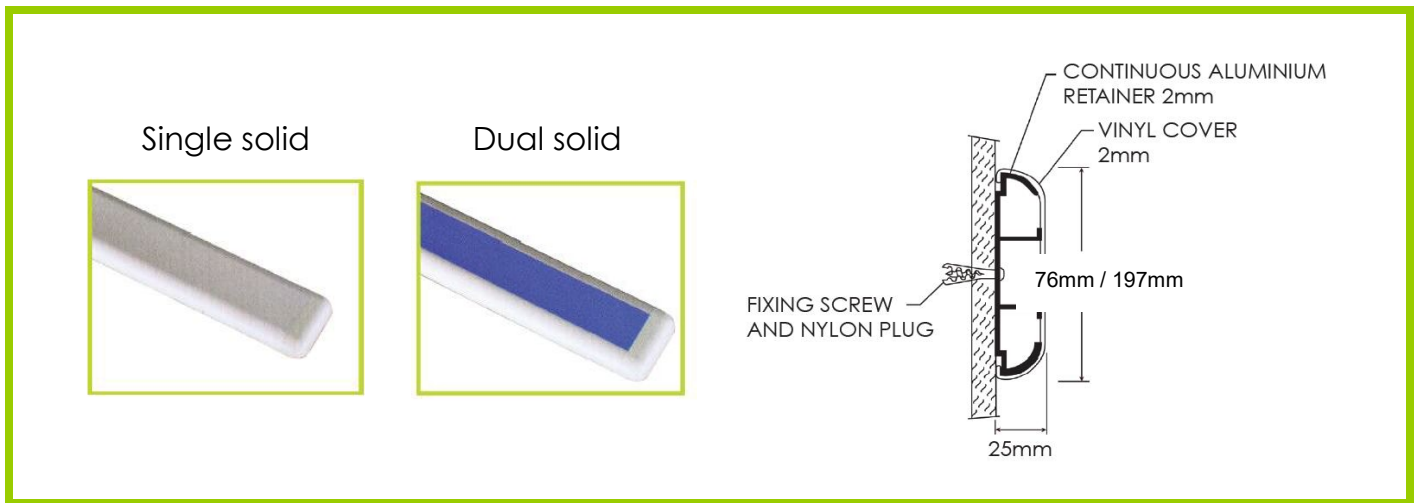

### System Information

- 2mm thick high impact extruded aluminum 6063-T5 retainer or clip
- 2mm thick high rigid vinyl cover
- Indoor Usage
- Single solid colour and dual solid colour available
- Up to 60 colours available (Confirm colour selections before purchase)

### Technical Data

Model	BG-F-S-76	BG-F-D-76	BG-F-S-197	BG-F-D-197
Height (mm)	76	76	197	197
Depth (mm)	25	25	25	25
Colour	Single Solid	Dual Solid	Single Solid	Dual Solid



# Australia Building Components

## Wall Protection System

### Bumper Guard

- Curve Type
- Model : WP-BG-C Series

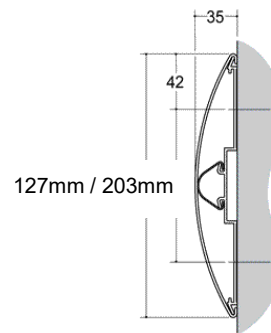

### System Information

- 2mm thick high impact extruded aluminum 6063-T5 retainer or clip
- Up to 60 colours available (Confirm colour selections before purchase)
- 2mm thick high rigid vinyl cover
- Indoor Usage

### Technical Data

Model	BG-C-127	BG-C-203
Height (mm)	127	203
Depth (mm)	27	35
Colour	Single Solid	Single Solid



# Australia Building Components

## Wall Protection System

### Bumper Guard

- Heavy Duty Rubber Type
- Model : RBG Series



### System Information

- UV resistance EPDM rubber
- Special dimension upon request
- Screw / Anchor fixing
- Indoor, outdoor & carpark usage
- High impact pressure
- Colour: Black

### Technical Data

Model	RBG-20/100	RBG-25/150	RBG-30/200	RBG-50/300
Height (mm)	100	150	200	300
Depth (mm)	20	25	30	50

## Wall Protection System

### Corner Guard

- ✔ Vinyl Type
- ✔ Model : WP-CG Series



### System Information

- ✔ 2mm thick high impact extruded aluminum 6063-T5 retainer or clip
- ✔ Continuous aluminum / Vinyl bracket
- ✔ 2mm thick high rigid vinyl cover
- ✔ Length on demand
- ✔ Indoor Usage
- ✔ Up to 60 colours available (Confirm colour selections before purchase)

### Technical Data

Model	CG-A-90-50	CG-V-90-50	CG-A-90-75	CG-V-90-75
Width(mm)	50 X 50	50 X 50	75 X 75	75 X 75
Angle	90	90	90	90
Retainer	Aluminum	Vinyl	Aluminum	Vinyl
Colour	Single solid	Single solid	Single solid	Single solid









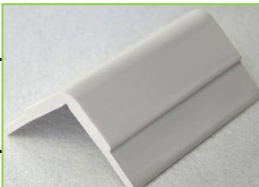

# Australia Building Components

## Wall Protection System

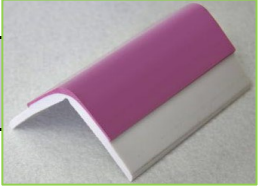
### Corner Guard

- Child Centre type
- Model : WP-RCG-8-50

Standard color	Base part	Warning strips	
	Green	Green	
	Grey	Grey	
	White	White	
	White	Blue	
	White	Purple	
	Yellow	Blue	
	Yellow	Red	
	Yellow	Green	

(Colour selection has to be confirmed before purchase)

### System Information

- Unibody rubber
- Over all thickness = 8 mm
- 6 mm base + 2mm Warning strips
- Indoor Usage
- Over all width = 50 x 50 mm
- 20mm Visible base + 30mm Warning strip
- 8 stock colours and up to 40 on demand selections available





# Australia Building Components

## Wall Protection System

### Corner Guard

- Heavy Duty Rubber Type
- Model : WP-RCG-S-18-100

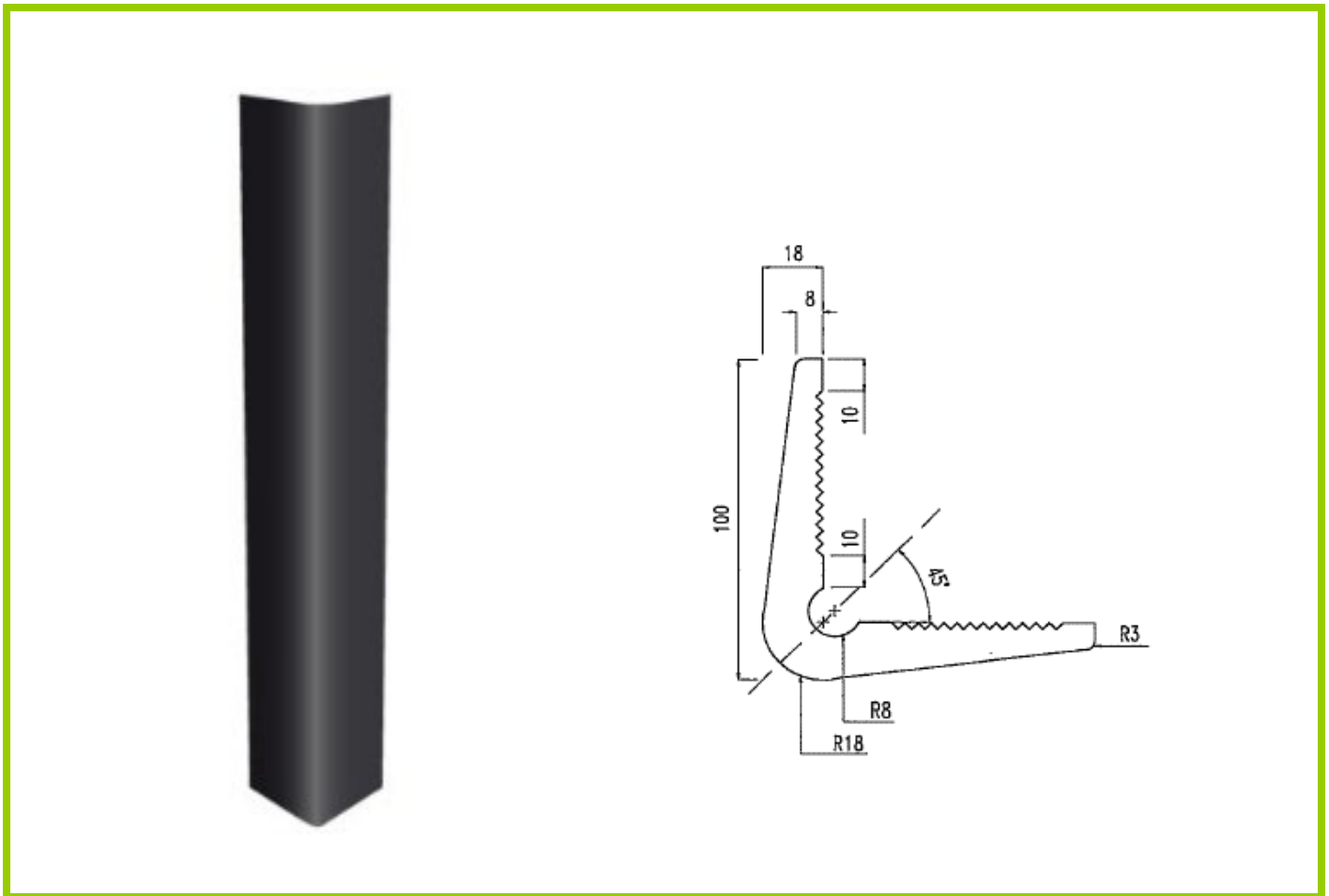

### System Information

- Material = Rubber
- Overall thickness = 18 mm
- Fixing : Liquid Nail / Screw and Plug
- Length = 400 to 2400 mm (Up to client's requirement)
- One pieces construction
- Overall width = 100 x 100 mm
- Black Colour



# Australia Building Components

## Wall Protection System

### Corner Guard

🌿 Metal Type

🌿 Model :

Aluminium WP-CG-AL-50

GMS WP-CG-GMS-50

Stainless Steel WP-CG-SS3xx-50



### System Information

🌿 Material : Aluminium / GMS / 304 Grade Stainless Steel

🌿 Hairline finish (Special treatment on request at time of order)

🌿 Thickness: 3.0mm to 5.0mm (On demand thickness available)

🌿 Width: 50mm x 50mm

🌿 High impact load

🌿 Indoor and outdoor usage

🌿 Fixing Material = Industrial adhesive or Diameter 8mm screw and plug

## Wall Protection System

### Handrail

- Flat Type
- Model : WP-HR-F-140

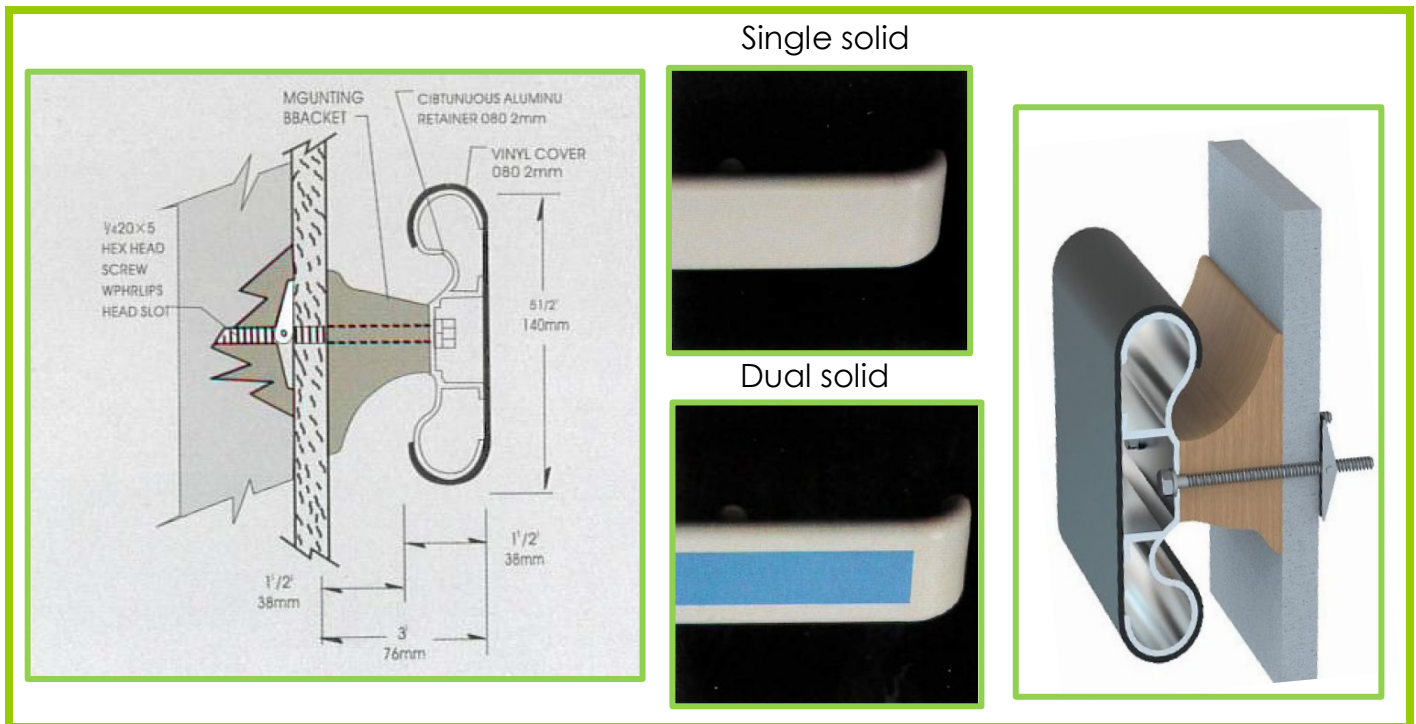

### System Information

- 2mm thick high impact extruded aluminum 6063-T5 retainer or clip
- 2mm thick high rigid vinyl cover
- Rail Height: 140mm, Bracket Height: 38mm
- On demand size available (MOQ applied)
- Single solid colour and dual solid colour available
- Up to 60 colours available (Confirm colour selections before purchase)
- High rigid vinyl bracket
- Indoor Usage



# Australia Building Components

## Wall Protection System

### Handrail

- Parasol Type
- Model : WP-HR-P-133

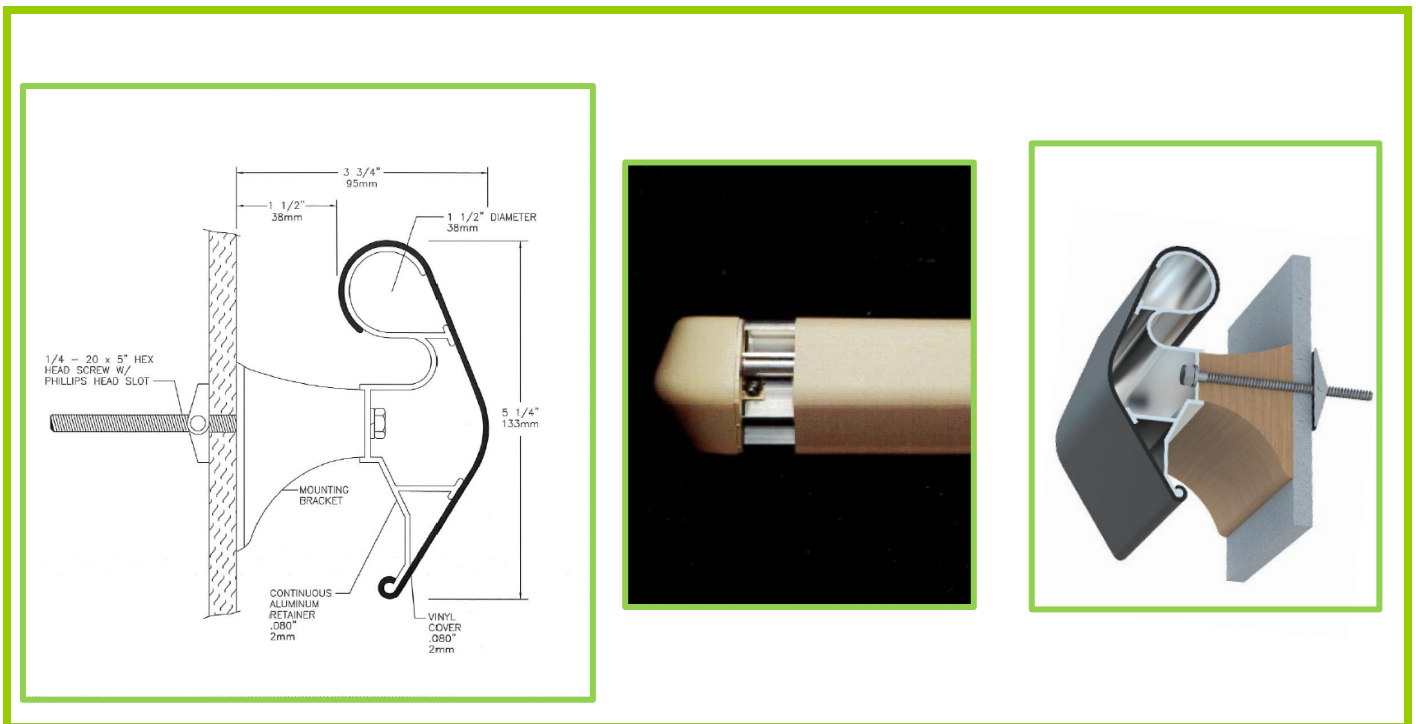

### System Information

- 2mm thick high impact extruded aluminum 6063-T5 retainer or clip
- 2mm thick high rigid vinyl cover
- Rail Height: 133mm
- Bracket Height: 38mm
- Up to 60 colours available (Confirm colour selections before purchase)
- On demand size available (MOQ applied)
- High rigid vinyl bracket
- Indoor Usage

Email: [info@aubuild.com.au](mailto:info@aubuild.com.au)

## Wall Protection System

### Handrail

- Shell Type
- Model : WP-HR-S-89

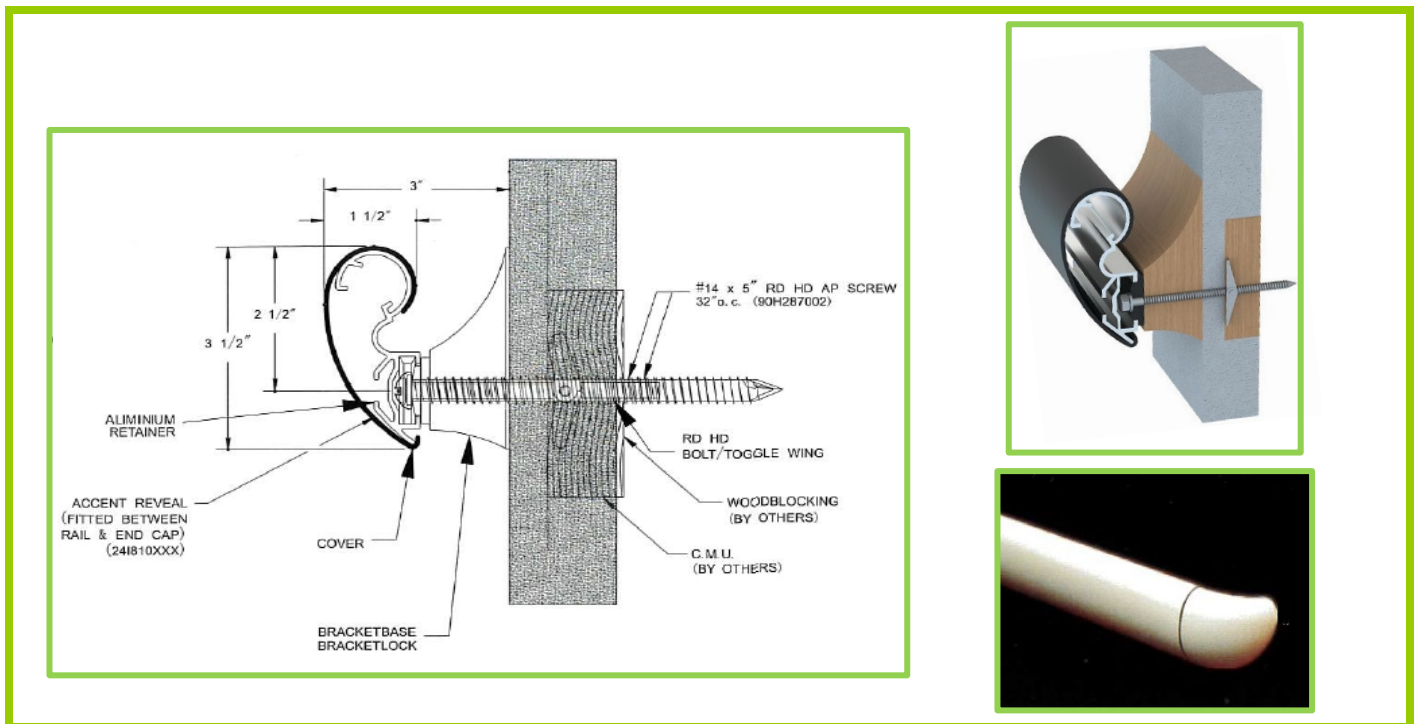

### System Information

- 2mm thick high impact extruded aluminum 6063-T5 retainer or clip
- 2mm thick high rigid vinyl cover
- Rail Height: 89mm
- Bracket Height: 38mm
- Up to 60 colours available (Confirm colour selections before purchase)
- On demand size available (MOQ applied)
- High rigid vinyl bracket
- Indoor Usage

## Wall Protection System

### Handrail

- ✔ Metal Type
- ✔ Model : SS-HR-038

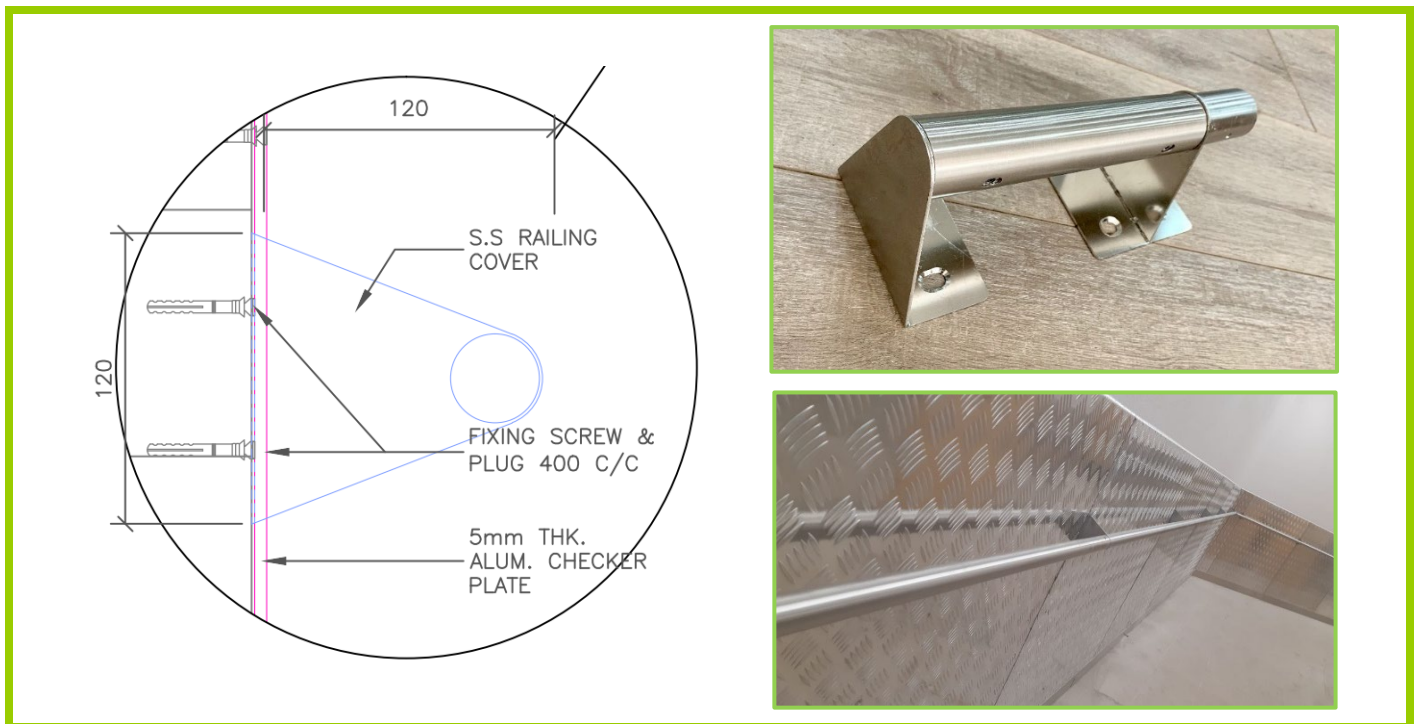

### System Information

- ✔ MATERIALS: Grade 304 or 316 STAINLESS STEEL TUBE and bracket
- ✔ Standard Thickness: 1.5mm
- ✔ Standard Rail Diameter: 38mm
- ✔ Standard Bracket Height: 89mm
- ✔ Standard Finishing: Hairline
- ✔ Custom design available
- ✔ Indoor & Outdoor Usage



# Australia Building Components

## Wall Protection System

### Wall Cover

- ✔ Vinyl Type
- ✔ Model : WS-SC Series



Joint Accessories	
	Top Cap
	Inside cover
	Outside cover
	Joint cover

### System Information

- ✔ Material : Rigid Vinyl
- ✔ Anti-collision constructed
- ✔ Antibacterial coating
- ✔ Curved cover available
- ✔ Industrial and commercial usage
- ✔ Fire resistance
- ✔ Up to 60 colours available (Confirm colour selections before purchase)

### Technical Data

Thickness	1.0, 1.5, 2.0, 3.0mm (Special size on request)
Normal Sheet Size (Width x Height)	1220mm x 2800mm (Special size on request)
Joint width size	~1.2mm
Fixing material	Industrial grade adhesive



# Australia Building Components

## Wall Protection System

### Wall Cover

✔ Metal Flat Type

✔ Model :

Aluminium ABC-CP-AL0x

GMS ABC-CP-GMS0x

Stainless Steel ABC-CP-SSxxx

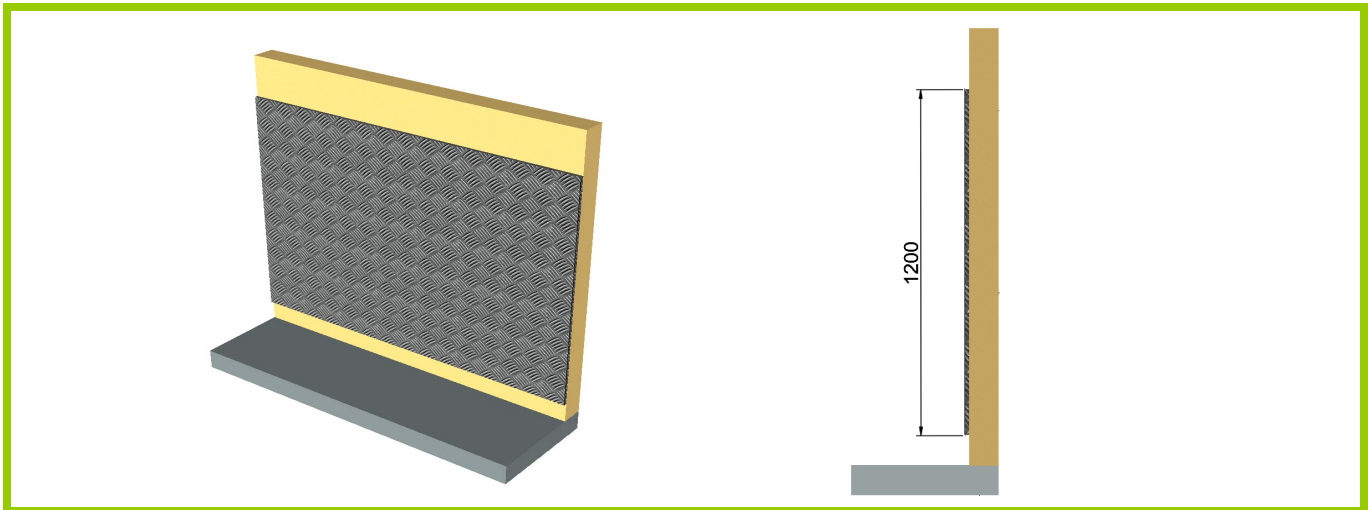

### System Features

- ✔ Material : Aluminium / GMS / 304 or 316 Grade Stainless Steel
- ✔ Chequer and Hairline pattern available
- ✔ Thickness: 3.0mm to 5.0mm (On demand thickness available)
- ✔ Sheet Size: 2400mm x 1220mm (On demand size available)
- ✔ Joint Type: 0.5mm width Butt joint or 1-2mm Caulk joint
- ✔ Fixing Material: Industrial adhesive and  $\varnothing$  6mm screw and plug





# Australia Building Components

## Wall Protection System

### Wall Cover

✔ Metal Bumpered Flat Type

✔ Model :

Aluminium ABC-CP-AL0x-BF

GMS ABC-CP-GMS0x-BF

Stainless Steel ABC-CP-SSxxx-BF

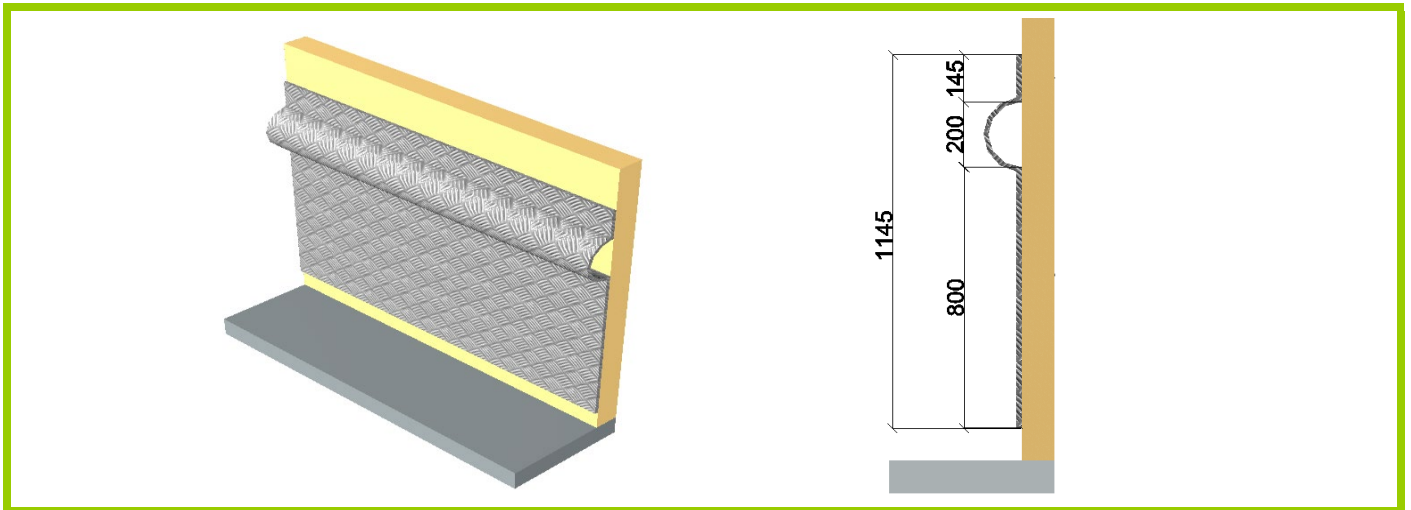

### System Features

- ✔ Covered bumper construction
- ✔ Material : Aluminium / GMS / 304 or 316 Grade Stainless Steel
- ✔ Chequer and Hairline pattern available
- ✔ Thickness: 3.0mm to 5.0mm (On demand thickness available)
- ✔ Sheet Size: 2400mm x 1220mm (On demand size available)
- ✔ Joint Type: 0.5mm width Butt joint or 1-2mm Caulk joint
- ✔ Fixing Material: Industrial adhesive and  $\varnothing$  6mm screw and plug



## Hong Kong Job Reference



Item	Project	Items of Works	Main Contractor / Client
1	Canossa Hospital	Vinyl System	Yau Lee / Canossa Hospital
2	North Lantau Hospital Phase 1	Vinyl System	Leighton / Hospital Authority
3	Tin Shui Wai Clinic	Vinyl System	Able / Hospital Authority
4	Macau studio city	Vinyl & Metal System	Paul Y / Studio city
5	MTR Contract 11209	Vinyl & Metal System	Chun Wo / MTR
6	Rolex - Cleaning Dept	Vinyl System	Rolex
7	Science Park 3C	Rubber System	Gammon / Science Park
8	Rolex Office	Vinyl System	ISG / Rolex
9	Hong Kong Jokey Club Happy Valley	Vinyl System	Chun Wo / Hong Kong Jokey Club
10	Tuen Mum Siu Lun Gov Complex	Vinyl, Rubber & Metal	Chevalier / ASD
11	700 Nathan Road	Vinyl System	Ching Lee
12	Tin Yiu Shopping Centre	Vinyl System	Ching Lee / Housing Department
13	Asia World Expo	Vinyl System	Asia World Expo
14	Wo Che Shopping Centre	Vinyl & Metal System	Ching Lee / Link REIT
15	Fu Cheong Shopping Centre	Vinyl System	Ching Lee / Link REIT
16	HKUST	Vinyl System	ISG / HKUST
17	Kei Tak Station (MTRC 1108)	Vinyl System	Chun Wo / MTR